

### FEATURES

#### Dual-mode inclinometer system

Dual-axis, horizontal operation,  $\pm 90^\circ$

Single-axis, vertical operation,  $\pm 180^\circ$

#### High accuracy, 0.1°

14-bit digital inclination data, 0.025° resolution

14-bit digital acceleration data, 0.244 mg resolution

$\pm 1.7 g$  accelerometer measurement range

12-bit digital temperature sensor output

Digitally controlled bias calibration

Digitally controlled sample rate

Digitally controlled frequency response

Dual alarm settings with rate/threshold limits

Auxiliary digital I/O

Digitally activated self-test

Digitally activated low power mode

SPI-compatible serial interface

Auxiliary 12-bit ADC input and DAC output

Single-supply operation: 3.0 V to 3.6 V

3500 g powered shock survivability

### APPLICATIONS

Platform control, stabilization, and alignment

Tilt sensing, inclinometers, leveling

Motion/position measurement

Monitor/alarm devices (security, medical, safety)

Navigation

### GENERAL DESCRIPTION

The ADIS16209 is a high accuracy, digital inclinometer that accommodates both single-axis ( $\pm 180^\circ$ ) and dual-axis ( $\pm 90^\circ$ ) operation. The standard supply voltage (3.3 V) and serial peripheral interface (SPI) enable simple integration into most industrial system designs. A simple internal register structure handles all output data and configuration features. This includes access to the following output data: calibrated acceleration, accurate incline angles, power supply, internal temperature, auxiliary analog and digital input signals, diagnostic error flags, and programmable alarm conditions.

### FUNCTIONAL BLOCK DIAGRAM

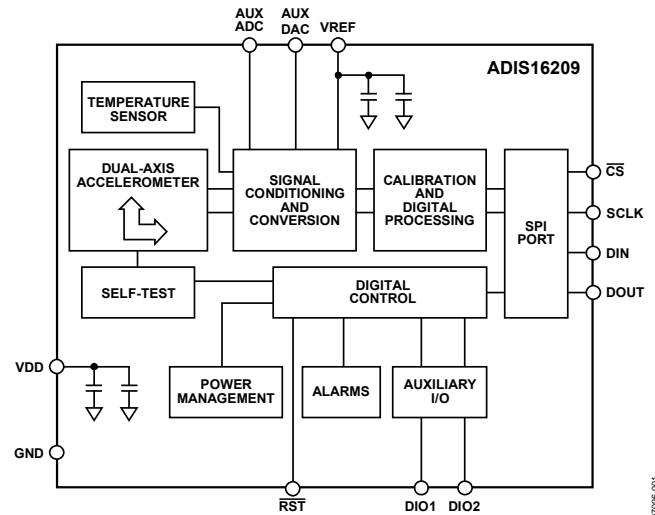

Figure 1.

Configurable operating parameters include sample rate, power management, digital filtering, auxiliary analog and digital output, offset/null adjustment, and self-test for sensor mechanical structure.

The ADIS16209 is available in a 9.2 mm  $\times$  9.2 mm  $\times$  3.9 mm LGA package that operates over a temperature range of  $-40^\circ\text{C}$  to  $+125^\circ\text{C}$ . It can be attached using standard RoHS-compliant solder reflow processes.

#### Rev. A

Information furnished by Analog Devices is believed to be accurate and reliable. However, no responsibility is assumed by Analog Devices for its use, nor for any infringements of patents or other rights of third parties that may result from its use. Specifications subject to change without notice. No license is granted by implication or otherwise under any patent or patent rights of Analog Devices. Trademarks and registered trademarks are the property of their respective owners.

## TABLE OF CONTENTS

Features .....	1	Pin Configuration and Function Descriptions.....	7
Applications.....	1	Recommended Pad Geometry .....	7
Functional Block Diagram .....	1	Typical Performance Characteristics .....	8
General Description .....	1	Theory of Operation .....	10
Revision History .....	2	Basic Operation .....	11
Specifications.....	3	Output Data Registers .....	12
Timing Specifications .....	5	Operation Control Registers.....	12
Timing Diagrams.....	5	Calibration Registers.....	14
Absolute Maximum Ratings.....	6	Alarm Registers .....	14
Thermal Resistance .....	6	Outline Dimensions .....	16
ESD Caution.....	6	Ordering Guide .....	16

## REVISION HISTORY

### 7/08—Rev. 0 to Rev. A

Changes to Figure 19.....	10
Changes to Table 21.....	15

### 3/08—Revision 0: Initial Version

## SPECIFICATIONS

T<sub>A</sub> = 25°C, VDD = 3.3 V, tilt = 0°, unless otherwise noted.

Table 1.

Parameter	Conditions	Min	Typ	Max	Unit
HORIZONTAL INCLINE	Each axis				
Input Range			±90		Degrees
Relative Accuracy	±30° from horizon, AVG_CNT = 0x08		±0.1		Degrees
Sensitivity	±30° from horizon		0.025		°/LSB
VERTICAL ROTATION	Rotational plane within ±30° of vertical				
Input Range		-180		+180	Degrees
Relative Accuracy	360° of rotation		±0.25		Degrees
Sensitivity	-40°C to +85°C		0.025		°/LSB
ACCELEROMETER	Each axis				
Input Range <sup>1</sup>	25°C	±1.7			g
Nonlinearity <sup>1</sup>	Percentage of full scale		±0.1	±0.2	%
Alignment Error	X sensor to Y sensor		±0.1		Degrees
Cross Axis Sensitivity			±2		%
Sensitivity	-40°C to +85°C, VDD = 3.0 V to 3.6 V	0.243	0.244	0.245	mg/LSB
ACCELEROMETER NOISE PERFORMANCE					
Output Noise	AVG_CNT = 0x00		1.7		mg rms
Noise Density	AVG_CNT = 0x00		0.19		mg/√Hz rms
ACCELEROMETER FREQUENCY RESPONSE					
Sensor Bandwidth			50		Hz
Sensor Resonant Frequency			5.5		kHz
ACCELEROMETER SELF-TEST STATE <sup>2</sup>					
Output Change When Active	At 25°C	706	1343	1973	LSB
TEMPERATURE SENSOR					
Output at 25°C			1278		LSB
Scale Factor			-0.47		°C/LSB
ADC INPUT					
Resolution			12		Bits
Integral Nonlinearity (INL)			±2		LSB
Differential Nonlinearity (DNL)			±1		LSB
Offset Error			±4		LSB
Gain Error			±2		LSB
Input Range		0		2.5	V
Input Capacitance	During acquisition		20		pF
ON-CHIP VOLTAGE REFERENCE					
Accuracy	At 25°C	-10		+10	mV
Reference Temperature Coefficient			±40		ppm/°C
Output Impedance			70		Ω
DAC OUTPUT	5 kΩ/100 pF to GND				
Resolution			12		Bits
Relative Accuracy	For Code 101 to Code 4095		4		LSB
Differential Nonlinearity			1		LSB
Offset Error			±5		mV
Gain Error			±0.5		%
Output Range			0 to 2.5		V
Output Impedance			2		Ω
Output Settling Time			10		μs

# ADIS16209

Parameter	Conditions	Min	Typ	Max	Unit	
<b>LOGIC INPUTS</b>						
Input High Voltage, $V_{INH}$	For $\overline{CS}$ signal when used to wake up from sleep mode $V_{IH} = 3.3\text{ V}$ $V_{IL} = 0\text{ V}$	2.0			V	
Input Low Voltage, $V_{INL}$				0.8	V	
Logic 1 Input High Current, $I_{INH}$				0.55	V	
Logic 0 Input Low Current, $I_{INL}$				$\pm 0.2$	$\pm 10$	$\mu\text{A}$
All Except $\overline{RST}$				-40	-60	$\mu\text{A}$
$\overline{RST}^3$				-1		$\text{mA}$
Input Capacitance, $C_{IN}$				10		$\text{pF}$
<b>DIGITAL OUTPUTS</b>						
Output High Voltage, $V_{OH}$	$I_{SOURCE} = 1.6\text{ mA}$	2.4			V	
Output Low Voltage, $V_{OL}$	$I_{SINK} = 1.6\text{ mA}$			0.4	V	
<b>SLEEP TIMER</b>						
Timeout Period <sup>4</sup>		0.5		128	Seconds	
<b>START-UP TIME<sup>5</sup></b>						
Power-On	Time until data is available Fast mode, $SMPL\_PRD \leq 0x07$ Normal mode, $SMPL\_PRD \geq 0x08$		150		ms	
Reset Recovery	Fast mode, $SMPL\_PRD \leq 0x07$ Normal mode, $SMPL\_PRD \geq 0x08$		190		ms	
Sleep Mode Recovery			30		ms	
			70		ms	
			2.5		ms	
<b>FLASH MEMORY</b>						
Endurance <sup>6</sup>	$T_J = 85^\circ\text{C}$	20,000			Cycles	
Data Retention <sup>7</sup>		20			Years	
<b>CONVERSION RATE SETTING</b>						
		1.04		2731	SPS	
<b>POWER SUPPLY</b>						
Operating Voltage Range	Normal mode, $SMPL\_PRD \geq 0x08$ Fast mode, $SMPL\_PRD \leq 0x07$ Sleep mode, $-40^\circ\text{C}$ to $+85^\circ\text{C}$	3.0	3.3	3.6	V	
Power Supply Current			11	14	$\text{mA}$	
			36	42	$\text{mA}$	
			140	350	$\mu\text{A}$	

<sup>1</sup> Guaranteed by iMEMS® packaged part testing, design, and/or characterization.

<sup>2</sup> Self-test response changes as the square of VDD.

<sup>3</sup> The  $\overline{RST}$  pin has an internal pull-up.

<sup>4</sup> Guaranteed by design.

<sup>5</sup> The times presented in this section do not include the sensor's transient response time, which is associated with a 50 Hz single-pole system. System accuracy goals should be given consideration when determining the amount of time it takes to start acquiring accurate readings. These times do not include the time it takes to arrive at thermal stability, which can also introduce transient errors.

<sup>6</sup> Endurance is qualified as per JEDEC Standard 22 Method A117 and measured at  $-40^\circ\text{C}$ ,  $+25^\circ\text{C}$ ,  $+85^\circ\text{C}$ , and  $+125^\circ\text{C}$ .

<sup>7</sup> Retention lifetime equivalent at junction temperature ( $T_J$ )  $55^\circ\text{C}$  as per JEDEC Standard 22 Method A117. Retention lifetime decreases with junction temperature.

## TIMING SPECIFICATIONS

$T_A = 25^\circ\text{C}$ ,  $V_{DD} = 3.3\text{ V}$ , tilt =  $0^\circ$ , unless otherwise noted.

**Table 2.**

Parameter	Description	Min <sup>1</sup>	Typ	Max	Unit
$f_{\text{SCLK}}$	Fast mode, $\text{SMPL\_PRD} \leq 0x07$ ( $f_s \geq 546\text{ Hz}$ ) <sup>2</sup> Normal mode, $\text{SMPL\_PRD} \geq 0x08$ ( $f_s \leq 482\text{ Hz}$ ) <sup>2</sup>	0.01		2.5	MHz
$t_{\text{Datarate}}$	Chip select period, fast mode, $\text{SMPL\_PRD} \leq 0x07$ ( $f_s \geq 546\text{ Hz}$ ) <sup>2</sup> Chip select period, normal mode, $\text{SMPL\_PRD} \geq 0x08$ ( $f_s \leq 482\text{ Hz}$ ) <sup>2</sup>	40		100	$\mu\text{s}$
$t_{\text{CS}}$	Chip select to clock edge	48.8			ns
$t_{\text{DAV}}$	Data output valid after SCLK edge			100	ns
$t_{\text{DSU}}$	Data input setup time before SCLK rising edge	24.4			ns
$t_{\text{DHD}}$	Data input hold time after SCLK rising edge	48.8			ns
$t_{\text{DF}}$	Data output fall time		5	12.5	ns
$t_{\text{DR}}$	Data output rise time		5	12.5	ns
$t_{\text{SFS}}$	$\overline{\text{CS}}$ high after SCLK edge	5			ns

<sup>1</sup> Guaranteed by design, not tested.

<sup>2</sup> Note that  $f_s$  means internal sample rate.

## TIMING DIAGRAMS

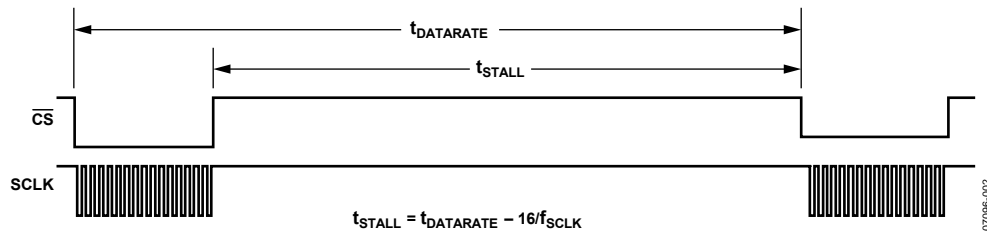

Figure 2. SPI Chip Select Timing

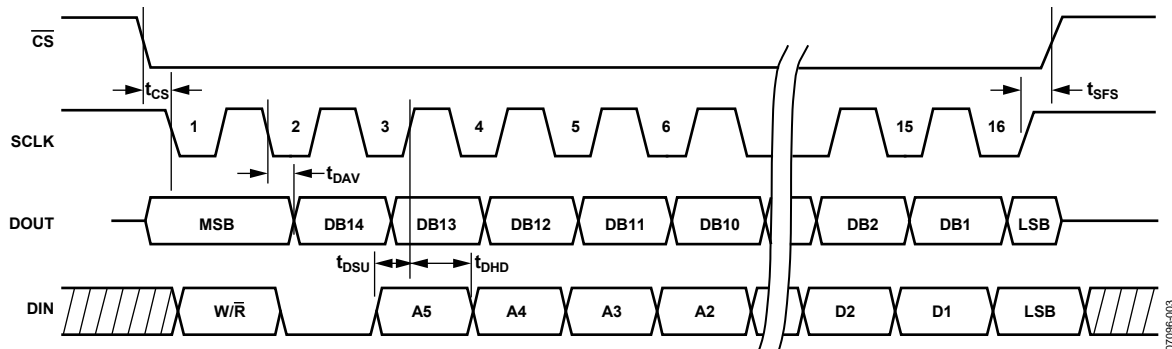

Figure 3. SPI Timing

(Utilizing SPI Settings Typically Identified as Phase = 1, Polarity = 1)

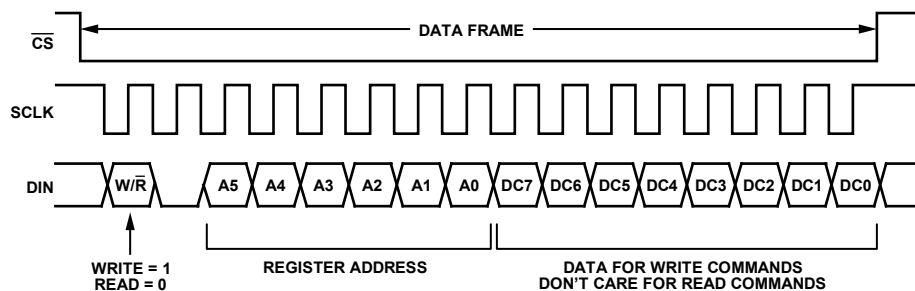

Figure 4. DIN Bit Sequence

# ADIS16209

## ABSOLUTE MAXIMUM RATINGS

Table 3.

Parameter	Rating
Acceleration (Any Axis, Unpowered)	3500 <i>g</i>
Acceleration (Any Axis, Powered)	3500 <i>g</i>
VDD to GND	−0.3 V to +7.0 V
Digital Input/Output Voltage to GND	−0.3 V to +5.5 V
Analog Inputs to GND	−0.3 to VDD + 0.3 V
Analog Inputs to GND	−0.3 to VDD + 0.3 V
Operating Temperature Range	−40°C to +125°C
Storage Temperature Range	−65°C to +150°C

Stresses above those listed under Absolute Maximum Ratings may cause permanent damage to the device. This is a stress rating only; functional operation of the device at these or any other conditions above those indicated in the operational section of this specification is not implied. Exposure to absolute maximum rating conditions for extended periods may affect device reliability.

## THERMAL RESISTANCE

Table 4. Package Characteristics

Package Type	$\theta_{JA}$	$\theta_{JC}$	Device Weight
16-Terminal LGA	250°C/W	25°C/W	0.6 g

## ESD CAUTION



**ESD (electrostatic discharge) sensitive device.** Charged devices and circuit boards can discharge without detection. Although this product features patented or proprietary protection circuitry, damage may occur on devices subjected to high energy ESD. Therefore, proper ESD precautions should be taken to avoid performance degradation or loss of functionality.

# PIN CONFIGURATION AND FUNCTION DESCRIPTIONS

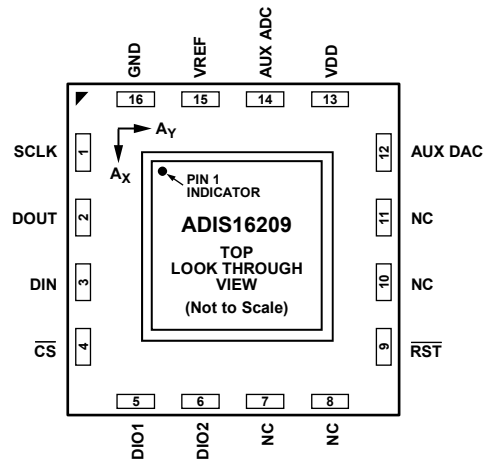

NOTES  
 1. NC = NO CONNECT.  
 2. THIS IS NOT AN ACTUAL TOP VIEW, BECAUSE THE PINS ARE NOT VISIBLE FROM THE TOP. THIS IS A LAYOUT VIEW THAT REPRESENTS THE PIN CONFIGURATION IF THE PACKAGE IS LOOKED THROUGH FROM THE TOP. THIS CONFIGURATION IS PROVIDED FOR PCB LAYOUT PURPOSES.

Figure 5. Pin Configuration

Table 5. Pin Function Descriptions

Pin No.	Mnemonic	Type <sup>1</sup>	Description
1	SCLK	I	SPI, Serial Clock.
2	DOUT	O	SPI, Data Output.
3	DIN	I	SPI, Data Input.
4	$\overline{CS}$	I	SPI, Chip Select.
5, 6	DIO1, DIO2	I/O	Digital Input/Output Pins.
7, 8, 10, 11	NC	N/A	No Connect.
9	$\overline{RST}$	I	Reset, Active Low.
12	AUX DAC	O	Auxiliary DAC Output.
13	VDD	S	Power Supply, 3.3 V.
14	AUX ADC	I	Auxiliary ADC Input.
15	VREF	O	Precision Reference.
16	GND	S	Ground.

<sup>1</sup> S = supply; O = output; I = input.

## RECOMMENDED PAD GEOMETRY

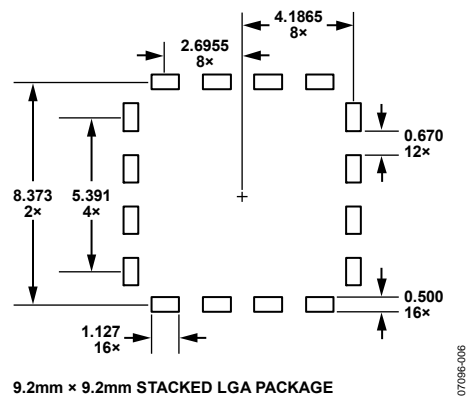

Figure 6. Example of a Pad Layout

## TYPICAL PERFORMANCE CHARACTERISTICS

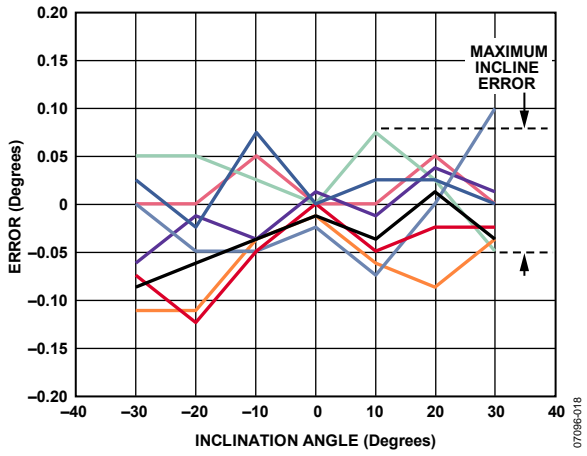

Figure 7. Horizontal Incline Error (Eight Parts), Autonull at Horizontal Position, Stable Temperature, 3.3 V

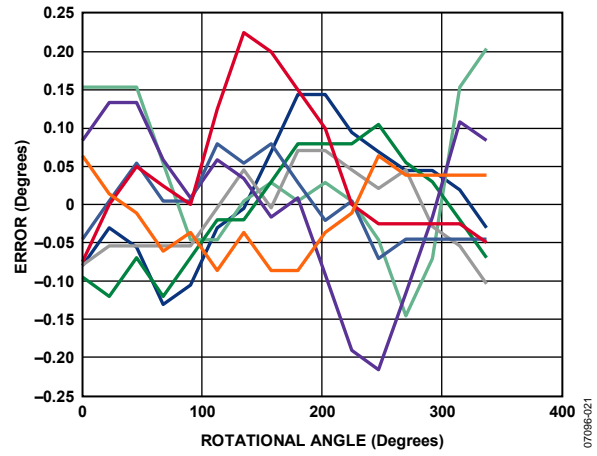

Figure 10. Vertical Mode Rotational Error (Eight Parts), 25°C, 3.3 V

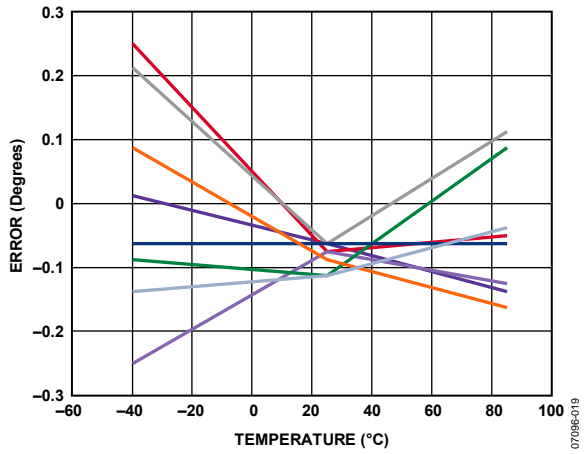

Figure 8. Maximum Incline Error Over a  $\pm 30^\circ$  Incline Range (Eight Parts) Over Temperature, Autonull at Horizontal Position, 25°C, 3.3 V

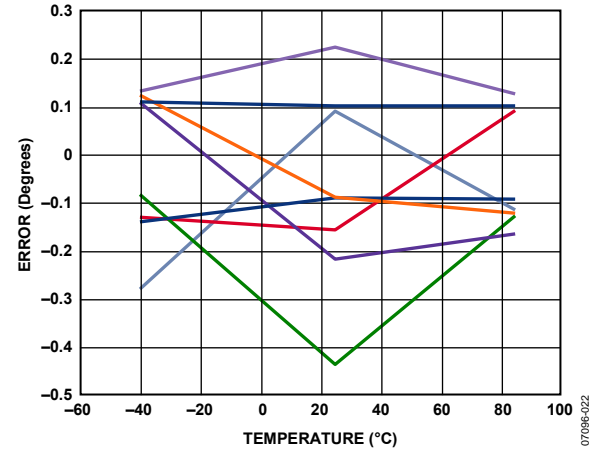

Figure 11. Vertical Mode Error (Eight Parts) vs. Temperature,  $0^\circ$  to  $360^\circ$ , 3.3 V

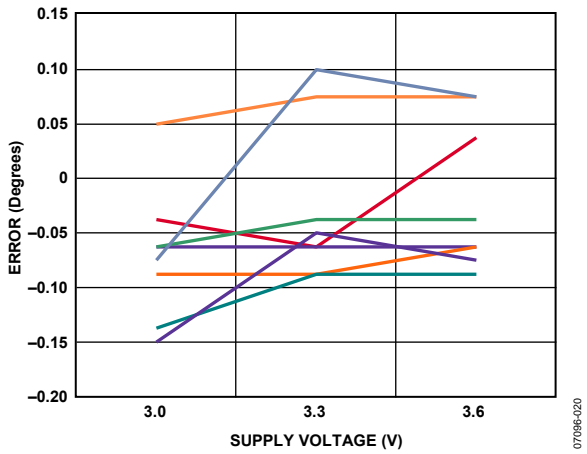

Figure 9. Maximum Incline Error Over a  $\pm 30^\circ$  Incline Range (Eight Parts) Over Supply Voltage, Autonull Horizontal Position, 25°C, 3.3 V

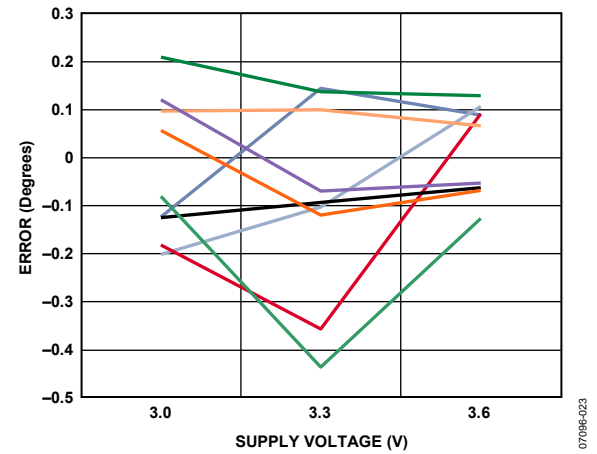

Figure 12. Vertical Mode Error (Eight Parts) vs. Supply Voltage,  $0^\circ$  to  $360^\circ$ , 25°C



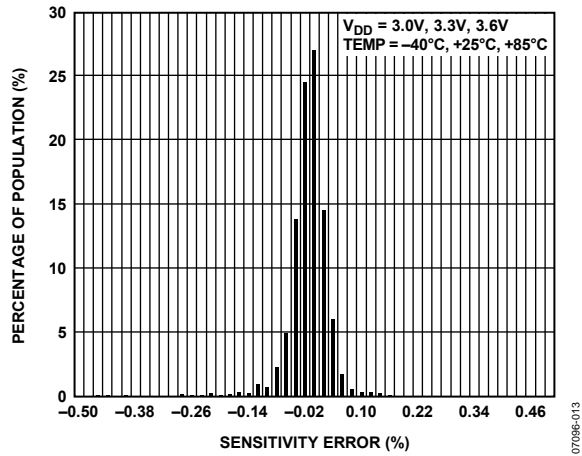

Figure 13. Accelerometer Output Sensitivity Error Distribution

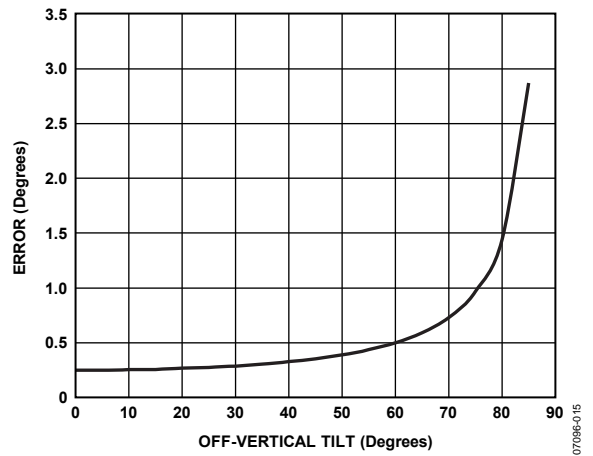

Figure 15. Error vs. Off-Vertical Tilt, 25°C, 3.3 V

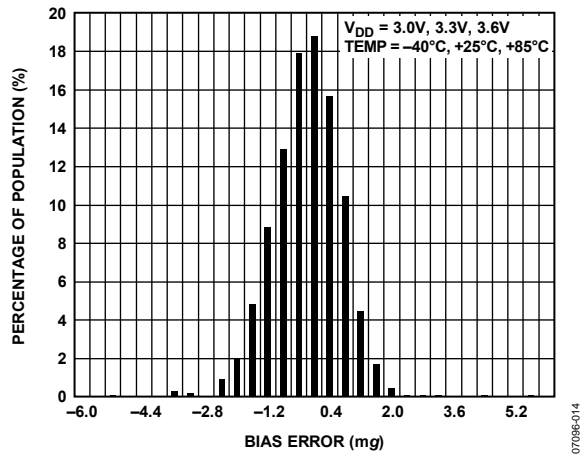

Figure 14. Accelerometer Output Bias Error Distribution

07096-013

07096-015

07096-014

## THEORY OF OPERATION

The ADIS16209 tilt sensing system uses gravity as its only stimulus, and a MEMS accelerometer as its sensing element. MEMS accelerometers typically employ a tiny, spring-loaded structure that is interlaced with a fixed pick-off finger structure. The spring constant of the floating structure determines how far it moves when subjected to a force. This structure responds to dynamic forces associated with acceleration and to static forces, such as gravity.

Figure 16 and Figure 17 illustrate how the accelerometer responds to gravity, according to its orientation, with respect to gravity. Figure 16 displays the configuration for the incline angle outputs, and Figure 17 displays the configuration used for the rotational angle position. This configuration provides greater measurement range than a single axis. The ADIS16209 incorporates the signal processing circuit that converts acceleration into an incline angle, and it corrects for several known error sources that would otherwise degrade the accuracy level.

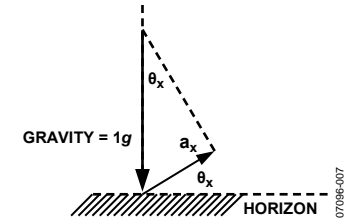

Figure 16. Single-Axis Tilt Theory Diagram

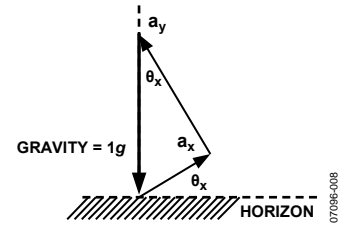

Figure 17. Dual-Axis Tilt Theory Diagram

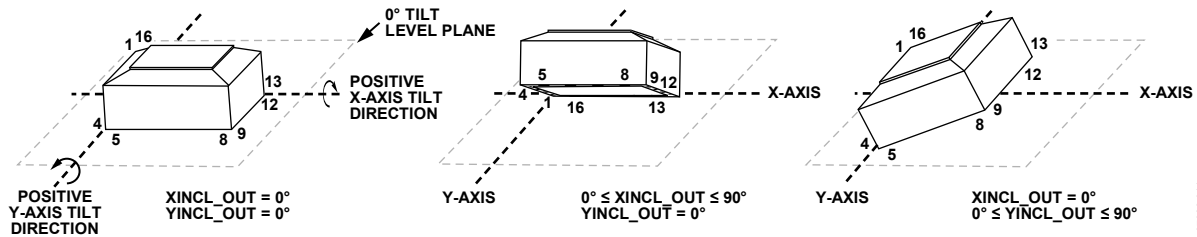

Figure 18. Horizontal Incline Angle Orientation

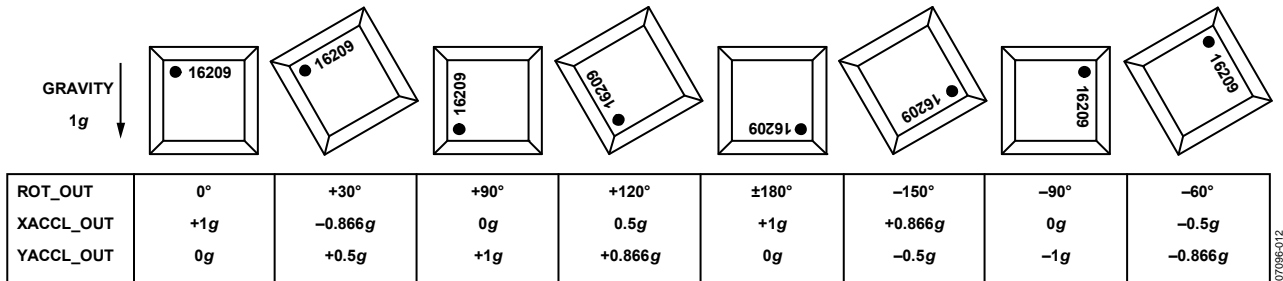

Figure 19. Vertical Angle Orientation

## BASIC OPERATION

The ADIS16209 requires only power/ground and SPI connections. The SPI is simple to hook up and is supported by many common digital hardware platforms. Figure 20 provides a simple hook-up diagram, while Table 2, Figure 2, and Figure 3 provide timing and bit assignments. Figure 4 provides the bit sequence for accessing the register memory structure. Each function within the ADIS16209 has its own 16-bit, 2-byte register. Each byte has its own unique 6-bit address. Note that all 16 SCLK cycles are required for the DIN bit sequence to configure the output for the next data frame. The ADIS16209 supports full duplex mode operation. Table 6 provides the entire user register map for the ADIS16209. For each register, the lower bytes address is given. For those registers that have two bytes, the upper bytes address is simply the lower bytes address, incremented by 0x01.

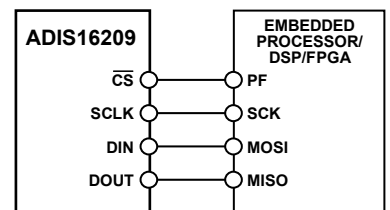

Figure 20. Typical SPI Hook-up

Many of the configuration registers have also been assigned mirror locations in the flash memory, which effectively provide them with a backup storage function. To ensure the backup of these registers, the COMMAND register provides an initiation bit for manual flash updates. The ENDURANCE register provides a running count of these events.

Table 6. User Register Map

Name	R/W	Flash Backup	Address	Size (Bytes)	Function	Reference
ENDURANCE	R	Yes	0x00	2	Diagnostics, flash write counter (16-bit binary)	
SUPPLY_OUT	R	No	0x02	2	Output, power supply	Table 7
XACCL_OUT	R	No	0x04	2	Output, x-axis acceleration	Table 7
YACCL_OUT	R	No	0x06	2	Output, y-axis acceleration	Table 7
AUX_ADC	R	No	0x08	2	Output, auxiliary ADC	Table 7
TEMP_OUT	R	No	0x0A	2	Output, temperature	Table 7
XINCL_OUT	R	No	0x0C	2	Output, $\pm 90^\circ$ x-axis inclination	Table 7
YINCL_OUT	R	No	0x0E	2	Output, $\pm 90^\circ$ y-axis inclination	Table 7
ROT_OUT	R	No	0x10	2	Output, $\pm 180^\circ$ vertical rotational position	Table 7
XACCL_NULL	R/W	Yes	0x12	2	Calibration, x-axis acceleration offset null	Table 16
YACCL_NULL	R/W	Yes	0x14	2	Calibration, y-axis acceleration offset null	Table 16
XINCL_NULL	R/W	Yes	0x16	2	Calibration, x-axis inclination offset null	Table 17
YINCL_NULL	R/W	Yes	0x18	2	Calibration, y-axis inclination offset null	Table 17
ROT_NULL	R/W	Yes	0x1A	2	Calibration, vertical rotation offset null	Table 17
			0x1C to 0x1F	4	Reserved, do not write to these locations	
ALM_MAG1	R/W	Yes	0x20	2	Alarm 1, amplitude threshold	Table 18
ALM_MAG2	R/W	Yes	0x22	2	Alarm 2, amplitude threshold	Table 18
ALM_SMPL1	R/W	Yes	0x24	2	Alarm 1, sample period	Table 19
ALM_SMPL2	R/W	Yes	0x26	2	Alarm 2, sample period	Table 19
ALM_CTRL	R/W	Yes	0x28	2	Alarm, source control register	Table 20
		No	0x2A to 0x2F	6	Reserved	
AUX_DAC	R/W	No	0x30	2	Auxiliary DAC data	Table 14
GPIO_CTRL	R/W	No	0x32	2	Operation, digital I/O configuration and data	Table 13
MSC_CTRL	R/W	No	0x34	2	Operation, data-ready and self-test control	Table 12
SMPL_PRD	R/W	Yes	0x36	2	Operation, sample rate configuration	Table 8
AVG_CNT	R/W	Yes	0x38	2	Operation, filter configuration	Table 10
SLP_CNT	W	Yes	0x3A	2	Operation, sleep mode control	Table 9
STATUS	R	No	0x3C	2	Diagnostics, system status register	Table 21
COMMAND	W	No	0x3E	2	Operation, system command register	Table 15

# ADIS16209

## OUTPUT DATA REGISTERS

Table 7 provides the data configuration for each output data register in the ADIS16209. Starting with the MSB of the upper byte, each output data register has the following bit sequence: new data (ND) flag, error/alarm (EA) flag, followed by 14 data bits. The data bits are LSB justified, and in the case of the 12-bit data formats, the remaining two bits are not used. The ND flag indicates that unread data resides in the output data registers. This flag clears and returns to 0 during an output register read sequence. It returns to 1 after the next internal sample update cycle completes. The EA flag indicates an error condition. The STATUS register contains all of the error flags and provides the ability to investigate the root cause.

**Table 7. Output Data Register Formats**

Register	Bits	Format	Scale <sup>1</sup>
SUPPLY_OUT	14	Binary, 3.3 V = 0x2A3D	0.30518 mV
XACCL_OUT	14	Twos complement	0.24414 mg
YACCL_OUT	14	Twos complement	0.24414 mg
AUX_ADC	12	Binary, 2 V = 0x0CCC	0.6105 mV
TEMP_OUT	12	Binary, 25°C = 0x04FE	-0.47°C
XINCL_OUT <sup>2</sup>	14	Twos complement	0.025°
YINCL_OUT <sup>2</sup>	14	Twos complement	0.025°
ROT_OUT <sup>3</sup>	14	Twos complement	0.025°

<sup>1</sup> Scale denotes quantity per LSB.

<sup>2</sup> Range is -90° to +90°.

<sup>3</sup> Range is -180° to +179.975°.

## OPERATION CONTROL REGISTERS

### Internal Sample Rate

The SMPL\_PRD register controls the ADIS16209 internal sample rate and has two parts: a selectable time base and a multiplier. The following relationship produces the sample rate:

$$t_s = t_B \times N_S + 122.07 \mu\text{s}$$

**Table 8. SMPL\_PRD Bit Descriptions**

Bit	Description	(Default = 0x0004)
15:8	Not used	
7	Time base ( $t_B$ ): 0 = 244.14 $\mu\text{s}$ , 1 = 7.568 ms	
6:0	Increment setting ( $N_S$ )	

An example calculation of the default sample period follows:

$$\text{SMPL\_PRD} = 0x01, B7 - B0 = 00000001$$

$$B7 = 0 \rightarrow t_B = 244.14 \mu\text{s}, B6 \dots B0 = 00000001 \rightarrow N_S = 1$$

$$t_s = t_B \times N_S + 122.07 \mu\text{s} = 244.14 \times 1 + 122.07 = 366.21 \mu\text{s}$$

$$f_s = 1/t_s = 2731 \text{ SPS}$$

The sample rate setting has a direct impact on the SPI data rate capability. For sample rates  $\geq 546$  SPS, the SPI SCLK can run at a rate up to 2.5 MHz. For sample rates  $< 546$  SPS, the SPI SCLK can run at a rate up to 1 MHz. The sample rate setting also affects power dissipation. When the sample rate is set to  $< 546$  SPS, power dissipation typically reduces by a factor

of 68%. The two different modes of operation offer a system-level trade-off between performance (sample rate, serial transfer rate) and power dissipation.

### Power Management

In addition to offering two different performance modes for power optimization, the ADIS16209 offers a programmable shutdown period that the SLP\_CNT register controls.

**Table 9. SLP\_CNT Bit Descriptions**

Bit	Description	(Default = 0x0000)
15:8	Not used	
7:0	Data bits, 0.5 seconds/LSB	

For example, writing 0x08 to the SLP\_CNT register places the ADIS16209 into sleep mode for 4 sec. The only way to stop this process is to remove power or reset the device.

### Digital Filtering

The AVG\_CNT register controls the moving average digital filter, which determines the size of the moving average filter in eight power-of-two step sizes (that is,  $2^M = 1, 2, 4, 16, 32, 64, 128,$  and  $256$ ). Filter setup requires one simple step: write the appropriate M factor to the assigned bits in the AVG\_CNT register.

**Table 10. AVG\_CNT Bit Descriptions**

Bit	Description	(Default = 0x0004)
15:4	Not used	
3:0	Power-of-two step size, maximum binary value = 1000	

The following equation offers a frequency response relationship for this filter:

$$H_A(f) = \frac{\sin(\pi \times N \times f \times t_s)}{N \times \sin(\pi \times f \times t_s)}$$

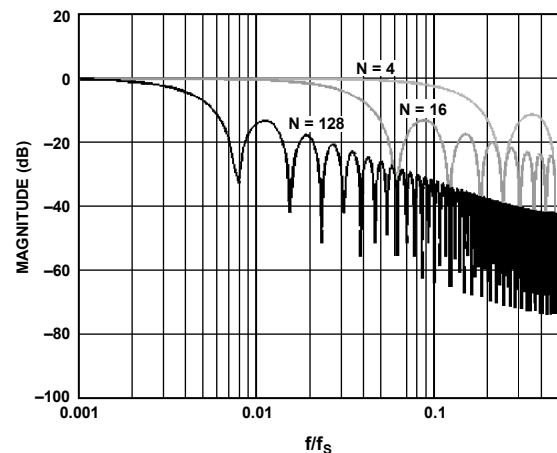

Figure 21. Frequency Response—Moving Average Filter

## Digital I/O Lines

The ADIS16209 provides two general-purpose, digital input/output lines that have several configuration options.

**Table 11. Digital I/O Line Configuration Registers**

Function	Priority	Register
Data-Ready I/O Indicator	1	MSC_CTRL
Alarm Indicator	2	ALM_CTRL
General-Purpose I/O Configuration	3	GPIO_CTRL
General-Purpose I/O Line Communication		GPIO_CTRL

### Data-Ready I/O Indicator

The MSC\_CTRL register provides controls for a data-ready function. For example, writing 0x05 to this register enables this function and establishes DIO2 as an active-low, data-ready line. The duty cycle is 25% ( $\pm 10\%$  tolerance).

**Table 12. MSC\_CTRL Bit Descriptions**

Bit	Description (Default = 0x0000)
15:11	Not used
10	Self-test at power-on: 1 = disabled, 0 = enabled
9	Not used
8	Self-test enable (temporary, bit is volatile): 1 = enabled, 0 = disabled
7:3	Not used
2	Data-ready enable: 1 = enabled, 0 = disabled
1	Data-ready polarity: 1 = active high, 0 = active low
0	Data-ready line select: 1 = DIO2, 0 = DIO1

### Self-Test

Self-test exercises the mechanical structure of the sensor and provides a simple method for verifying the operation of the entire sensor signal conditioning circuit. There are two different self-test options: startup and manual. If either of these self-tests results in a failure, the self-test error flag, located in the STATUS register, sets to 1. The manual self-test option results in a repeating pattern until the bit is set back to 0. While in the manual self-test loop, SMPL\_PRD and AVG\_CNT cannot be changed. See Table 12 for the appropriate MSC\_CTRL bit designations.

### General-Purpose I/O

The GPIO\_CTRL register controls the direction and data of the general-purpose digital lines, DIO1 and DIO2. For example, writing a 0x02 to the GPIO\_CTRL register sets DIO2 as an output line and DIO1 as an input line. Reading the data bits in GPIO\_CTRL reveals the line logic level.

**Table 13. GPIO\_CTRL Bit Descriptions**

Bit	Description (Default = 0x0000)
15:10	Not used
9	General-Purpose I/O Line 2 data
8	General-Purpose I/O Line 1 data
7:2	Not used
1	General-Purpose I/O Line 2, data direction control: 1 = output, 0 = input
0	General-Purpose I/O Line 1, data direction control: 1 = output, 0 = input

### Auxiliary DAC

The auxiliary DAC provides a 12-bit level adjustment function. The AUX\_DAC register controls the operation of the auxiliary DAC function, which is useful for systems that require analog level controls. It offers a rail-to-rail buffered output that has a range of 0 V to 2.5 V. The DAC can drive its output to within 5 mV of the ground reference when it is not sinking current. As the output approaches ground, the linearity begins to degrade (100 LSB beginning point). As the sink current increases, the nonlinear range increases. The DAC output latch function, contained in the COMMAND register, provides continuous operation while writing to each byte of this register. The contents of this register are volatile, which means that the desired output level must be set after every reset and power cycle event.

**Table 14. AUX\_DAC Bit Descriptions**

Bit	Description (Default = 0x0000)
15:12	Not used
11:0	Data bits, scale factor = 0.6105 mV/code Offset binary format, 0 V = 0 codes

### Global Commands

The COMMAND register provides initiation bits for several commands that simplify many common operations. Writing a 1 to the assigned COMMAND bit exercises its function.

**Table 15. COMMAND Bit Descriptions**

Bit	Description (Default = 0x0000)
15:8	Not used
7	Software reset
6:5	Not used
4	Clear status register (reset all bits to 0)
3	Flash update; backs up all registers, see Table 6
2	DAC data latch
1	Factory calibration restore
0	Autonull

The software reset command restarts the internal processor, which loads all registers with the contents in their flash memory locations.

# ADIS16209

The flash update copies the contents of all the flash backup registers into their assigned, nonvolatile flash memory locations. This process takes approximately 50 ms and requires a power supply that is within the specified operating range. After waiting the appropriate time for the flash update to complete, verify successful completion by reading the STATUS register (if successful, the flash update error is 0). If the flash update was not successful, reading this error bit accomplishes two things: it alerts the system processor to try again, and it clears the error flag, which is required for flash memory access.

The DAC data latch command loads the contents of AUX\_DAC into the DAC latches. Because the AUX\_DAC contents must be updated one byte at a time, this command ensures a stable DAC output voltage during updates.

The autonull command provides a simple method for removing offset from the sensor outputs. This command takes the contents of the output data registers and loads the equal but opposite number into the offset calibration registers. The accuracy of this operation depends on zero force, zero motion, and optimal noise management during the measurement (see the Digital Filtering section). The factory calibration restore sets the offset null registers (XACCL\_NULL, for example) back to their default values.

## CALIBRATION REGISTERS

The ADIS16209 incorporates an extensive factory calibration and provides precision acceleration, incline, and rotational position data. For systems that require on-site calibration, user-programmable offset adjustment registers are available.

Table 16 provides the bit assignments for the following user-programmable calibration registers: XACCL\_NULL and YACCL\_NULL. Table 17 provides the bit assignments for the following user-programmable calibration registers: XINCL\_NULL, YINCL\_NULL, and ROT\_NULL.

**Table 16. Acceleration Offset Register Bit Designations**

Bit	Description (Default = 0x0000)
15:14	Not used
13:0	Data bits, twos complement, sensitivity = 0.24414 mg/LSB

**Table 17. Incline/Rotation Offset Register Bit Designations**

Bit	Description (Default = 0x0000)
15:14	Not used
13:0	Data bits, twos complement, sensitivity = 0.025°/LSB

## ALARM REGISTERS

The alarm function provides monitoring for two independent conditions. The ALM\_CTRL register provides control inputs for data source, data filtering (prior to comparison), static/dynamic, and output indicator configurations. The ALM\_MAGx registers establish the trigger threshold and polarity configurations. The ALM\_SMPLx registers provide the numbers of samples to use in the dynamic rate-of-change configuration. The rate-of-change calculation is

$$Y_C = \frac{1}{N_{DS}} \sum_{n=1}^{N_{DS}} y(n+1) - y(n) \Rightarrow Alarm \Rightarrow \text{is } Y_C > \text{ or } < M_C ?$$

where:

$N_{DS}$  is the number of samples in ALM\_SMPLx.

$y(n)$  is the sampled output data.

$M_C$  is the magnitude for comparison in ALM\_MAGx.

> or < is determined by the MSB in ALM\_MAGx.

**Table 18. ALM\_MAG1/ALM\_MAG2 Bit Designations**

Bit	Description (Default = 0x0000)
15	Comparison polarity: 1 = greater than, 0 = less than
14	Not used
13:0	Data bits, matches format of trigger source selection

**Table 19. ALM\_SMPL1/ALM\_SMPL2 Bit Designations**

Bit	Description (Default = 0x0001)
15:8	Not used
7:0	Data bits: number of samples (both 0x00 and 0x01 = 1)

**Table 20. ALM\_CTRL Bit Descriptions**

Bit	Value	Description (Default = 0x0000)
15:12		Trigger source, Alarm 2
	0000	Disabled
	0001	Power supply
	0010	X-acceleration
	0011	Y-acceleration
	0100	Auxiliary ADC
	0101	Temperature sensor
	0110	X-axis incline angle
	0111	Y-axis incline angle
	1000	Rotational position
11:8		Trigger source, Alarm 1, same as Bits[15:12]
7		Not used
6		Alarm 2 rate-of-change control: 1 = enabled
5		Alarm 1 rate-of-change control: 1 = enabled
4		Alarm 2 filter: 1 = filtered data, 0 = no filter <sup>1</sup>
3		Alarm 1 filter: 1 = filtered data, 0 = no filter <sup>1</sup>
2		Alarm indicator, using DIO1/DIO2: 1 = enabled
1		Alarm indicator polarity: 1 = active high
0		Alarm indicator line select: 1 = DIO2, 0 = DIO1

<sup>1</sup> Incline and vertical angles always use filtered data in this comparison.

**Status**

The STATUS register provides a series of error flags that provide indicator functions for common system-level issues. All of the flags clear (set to 0) after each STATUS register read cycle. If an error condition remains, the error flag returns to 1 during the next sample cycle.

**Table 21. STATUS Bit Descriptions**

<b>Bit</b>	<b>Description</b>	<b>(Default = 0x0000)</b>
15:10	Not used	
9	Alarm 2 status: 1 = active, 0 = inactive	
8	Alarm 1 status: 1 = active, 0 = inactive	
7:6	Not used	
5	Self-test diagnostic error flag: 1 = error condition, 0 = normal operation	
4	Not used	
3	SPI communications failure: 1 = error condition, 0 = normal operation	
2	Flash update failed: 1 = error condition, 0 = normal operation	
1	Power supply greater than 3.625 V: 1 > 3.625 V, 0 ≤ 3.625 V (normal)	
0	Power supply less than 2.975 V: 1 < 2.975 V, 0 ≥ 2.975 V (normal)	

# ADIS16209

## OUTLINE DIMENSIONS

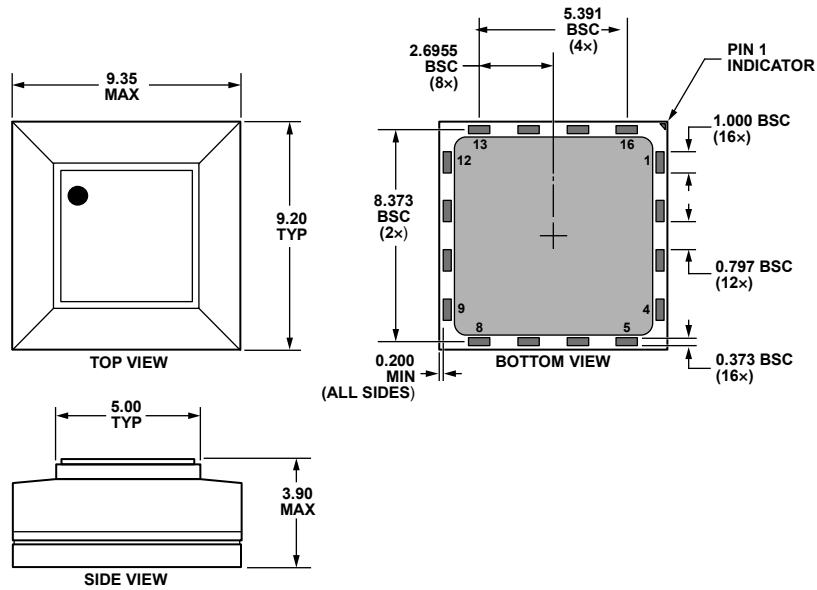

Figure 22. 16-Terminal Land Grid Array [LGA]  
(CC-16-2)  
Dimensions shown in millimeters

## ORDERING GUIDE

Model	Temperature Range	Package Description	Package Option
ADIS16209CCCZ <sup>1</sup>	-40°C to +125°C	16-Terminal Land Grid Array [LGA]	CC-16-2
ADIS16209/PCBZ <sup>1</sup>		Evaluation Board	

<sup>1</sup> Z = RoHS Compliant Part.